

GPS+LTE MIMO Combination Antenna

JCB305LM

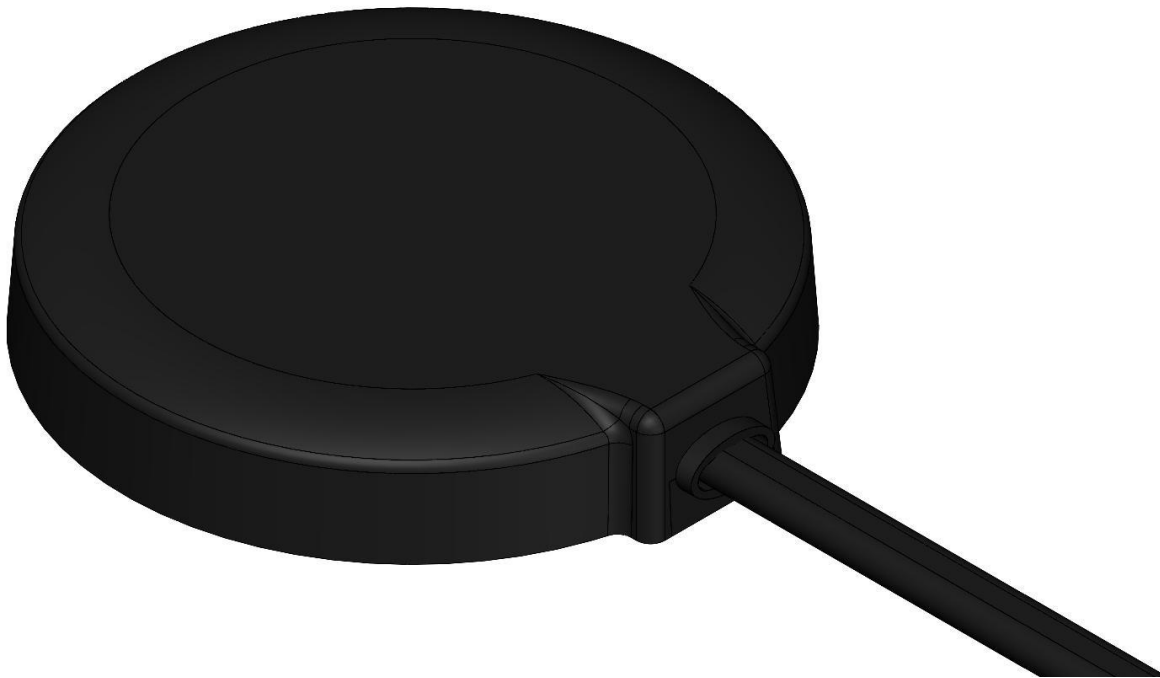

DIMENSIONS

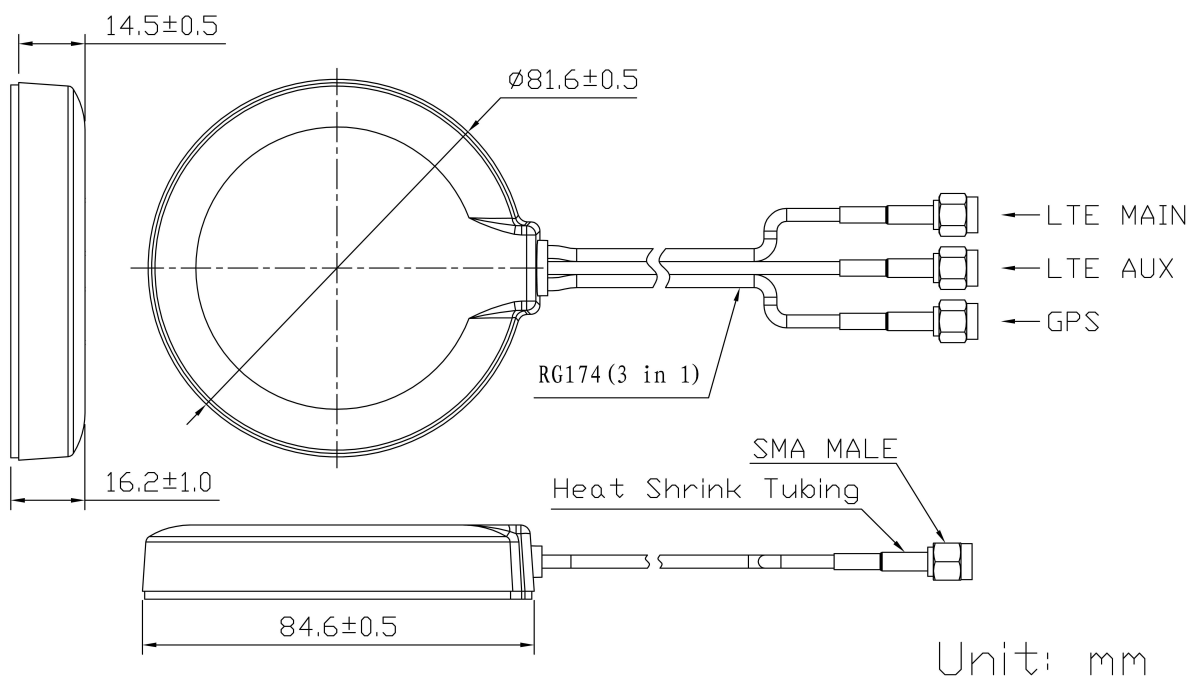

SPECIFICATIONS

Item		Specifications	
GPS Antenna	Dielectric Antenna	Frequency Range	1575.42 ± 3MHz
		Polarization	RHCP
		Gain	2dBic (Zenith)
		V.S.W.R	<1.5
		Impedance	50Ω
	LNA	Gain	28±2dB
		Noise Figure	<1.5dB
		V.S.W.R	<2.0
		Supply Voltage	3~5V DC
		Current Consumption	<15mA
LTE Antenna MAIN	Frequency Range	698~960MHz/1710~2690MHz	
	V.S.W.R	<3.0	
	Polarization	Linear	
	Gain	2.5dBi (Zenith)	
	Impedance	50Ω	
LTE Antenna AUX	Frequency Range	698~960MHz/1710~2690MHz	
	V.S.W.R	<3.0	
	Polarization	Linear	
	Gain	2.0dBi (Zenith)	
	Impedance	50Ω	
Mechanical	Cable	RG174	
	Connector	SMA/FAKRA or others	
	Material	ABS	
	Mounting Method	Adhesive/Magnet	
Environmental	Operating Temperature	-40℃~+85℃	
	Relative Humidity	Up to 95%	
	Ingress Protection	IP67	
	Vibration	10 to 55Hz with 1.5mm amplitude 2hours	
	Environmentally Friendly	ROHS Compliant	

Radiation Pattern

GPS Antenna

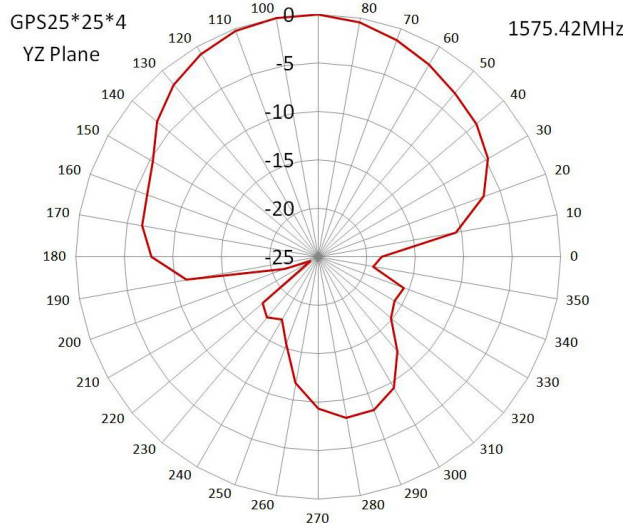
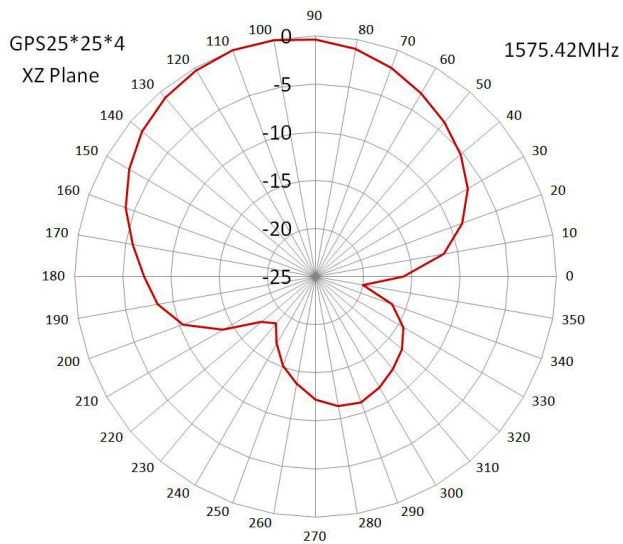
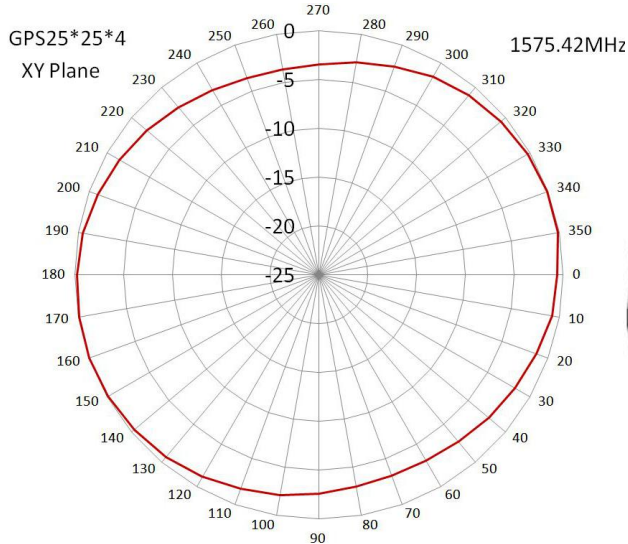

JIAXING JINCHANG ELECTRONIC TECHNOLOGY CO.,LTD

Add: 398#, Zhenye Road, South Street, Jiaxing, Zhejiang, China

Http:// www.jinchanggps.com

E-mail: jcgps@vip.163.com

Tel: 86-0573-83692157/83692605/83958637 Fax: 86-0573-83958635

LTE Antenna MAIN

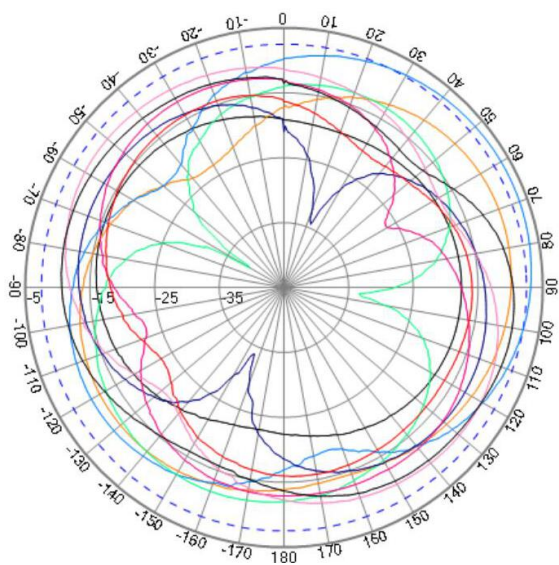

XY PLANE

- 测试频率: 700
- 测试频率: 824
- 测试频率: 868
- 测试频率: 960
- 测试频率: 1710
- 测试频率: 1850
- 测试频率: 1990
- 测试频率: 2170
- 测试频率: 2690

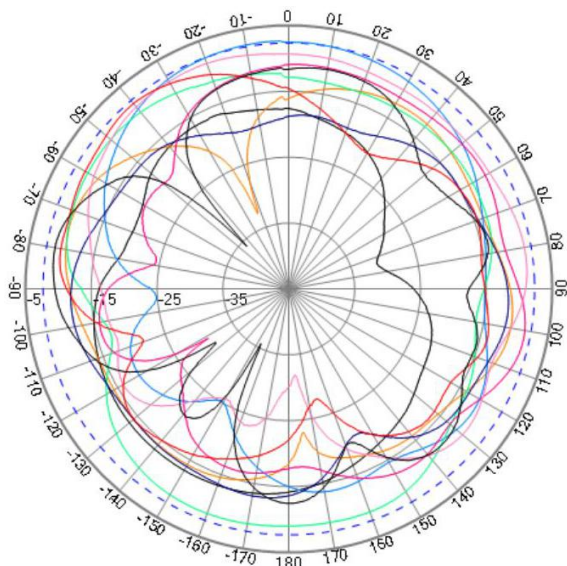

XZ PLANE

- 测试频率: 700
- 测试频率: 824
- 测试频率: 868
- 测试频率: 960
- 测试频率: 1710
- 测试频率: 1850
- 测试频率: 1990
- 测试频率: 2170
- 测试频率: 2690

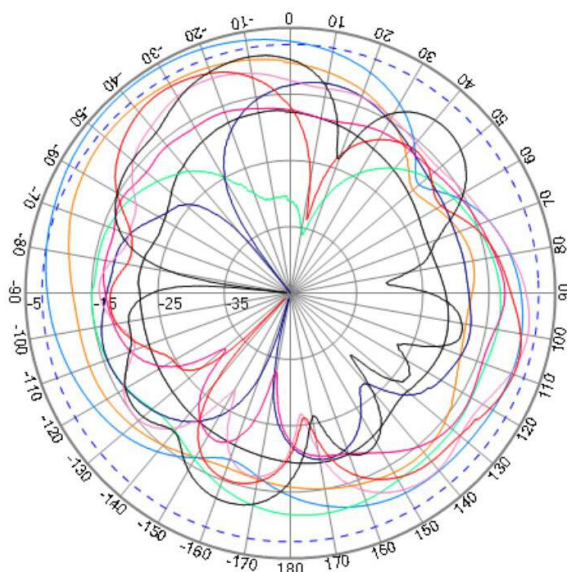

YZ PLANE

- 测试频率: 700
- 测试频率: 824
- 测试频率: 868
- 测试频率: 960
- 测试频率: 1710
- 测试频率: 1850
- 测试频率: 1990
- 测试频率: 2170
- 测试频率: 2690

LTE Antenna AUX

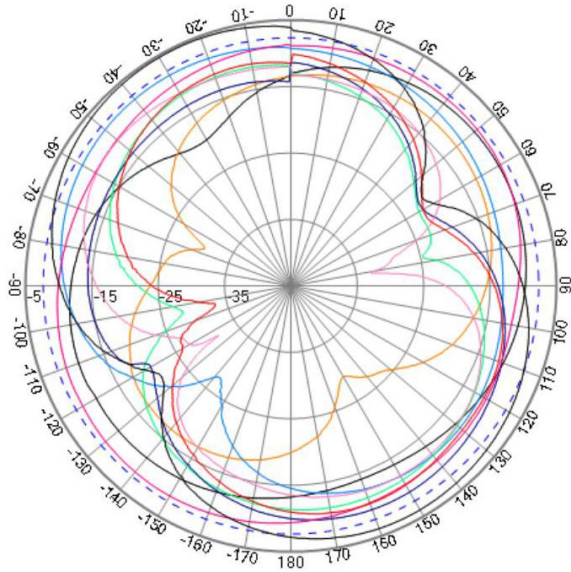

XY PLANE

- 测试频率: 700
- 测试频率: 824
- 测试频率: 868
- 测试频率: 960
- 测试频率: 1710
- 测试频率: 1850
- 测试频率: 1990
- 测试频率: 2170
- 测试频率: 2690

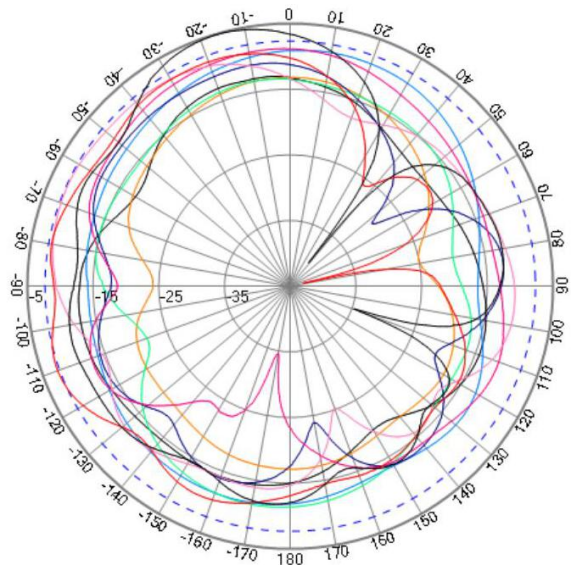

XZ PLANE

- 测试频率: 700
- 测试频率: 824
- 测试频率: 868
- 测试频率: 960
- 测试频率: 1710
- 测试频率: 1850
- 测试频率: 1990
- 测试频率: 2170
- 测试频率: 2690

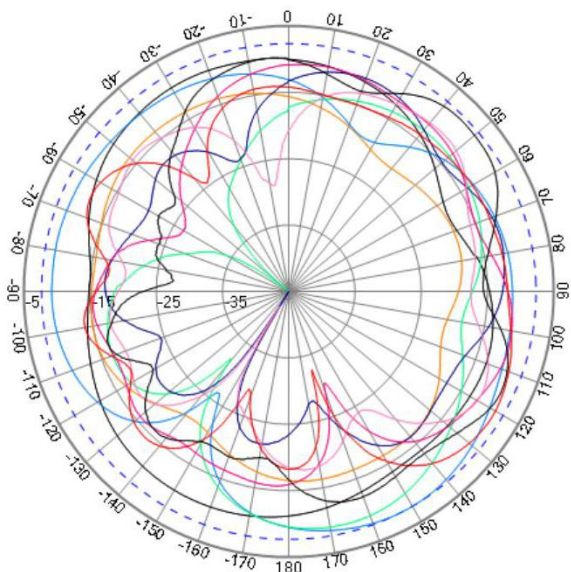

YZ PLANE

- 测试频率: 700
- 测试频率: 824
- 测试频率: 868
- 测试频率: 960
- 测试频率: 1710
- 测试频率: 1850
- 测试频率: 1990
- 测试频率: 2170
- 测试频率: 2690